

# CS 770

OPERATING INSTRUCTIONS

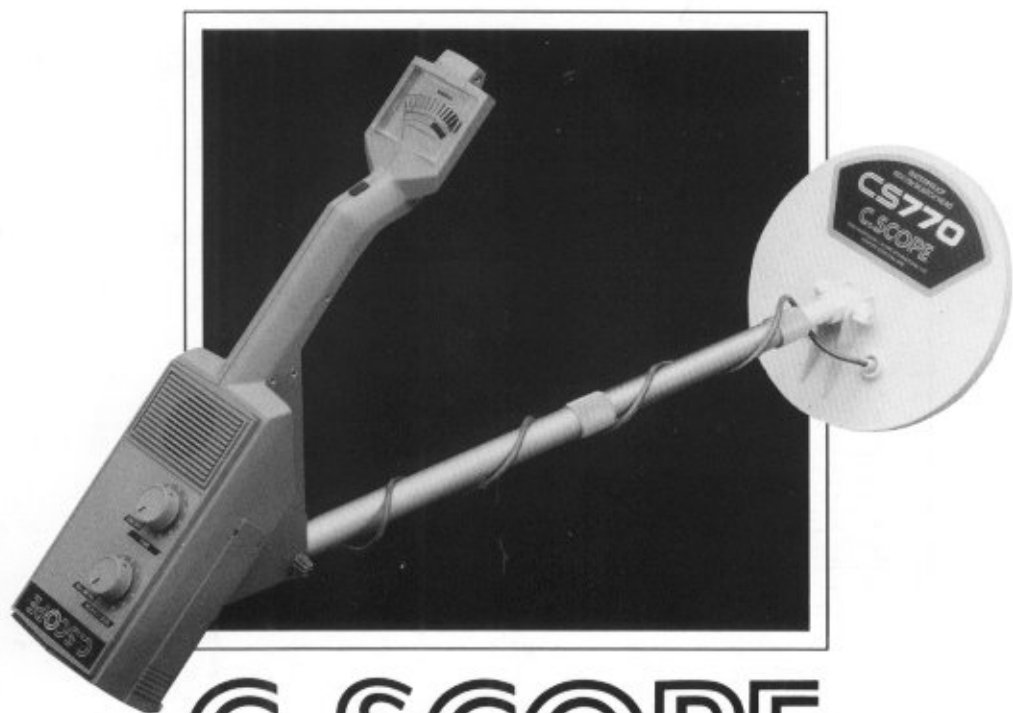

# C.SCOPE

## C-SCOPE METAL DETECTORS

### CS770 DISCRIMINATOR

You are now the owner of a C-Scope CS770 metal detector. C-Scope detectors are recognised as one of the finest metal detectors available. They are designed and manufactured to the highest standard to give you the maximum enjoyment and success. In order to obtain the best results it is **IMPORTANT** that you read and follow these instructions.

Diagram 1.

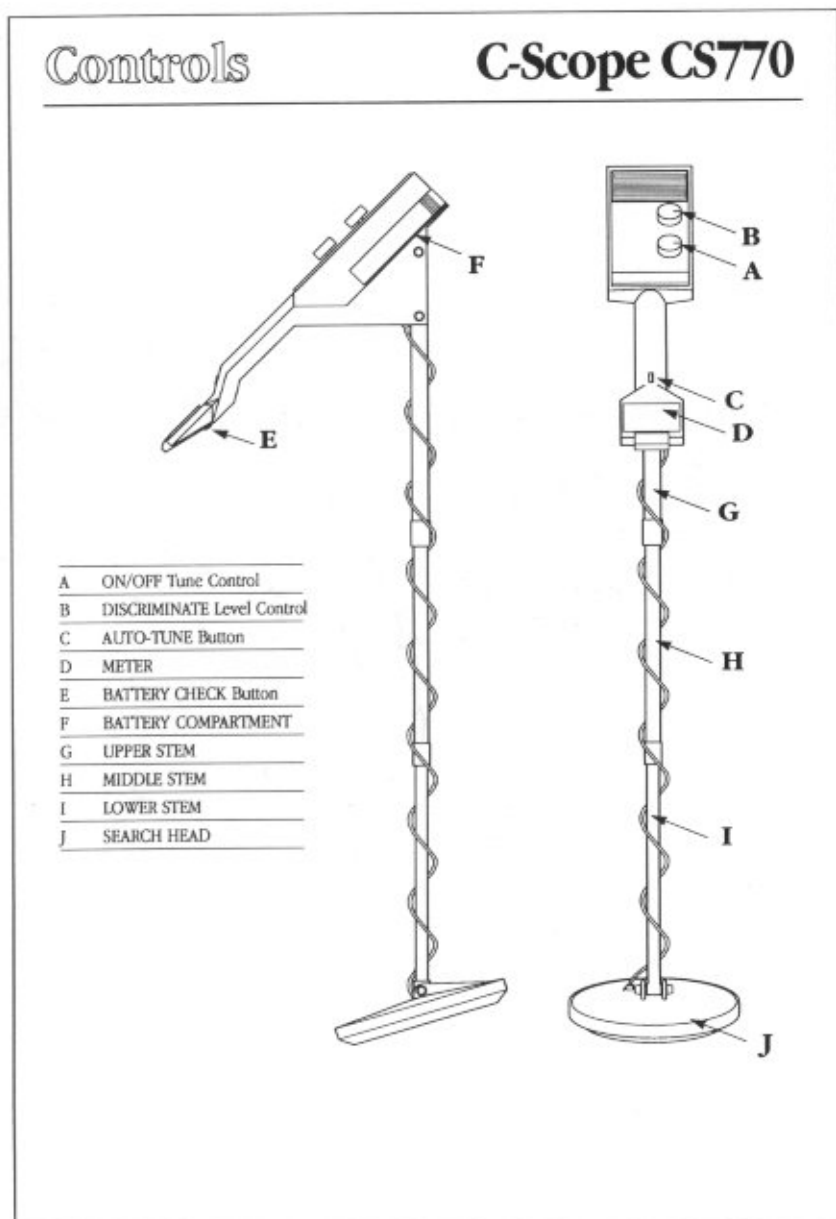

## ASSEMBLY AND BATTERIES

Your CS770 comes to you broken down for packaging. To assemble, insert the thickest pipe with drilled holes into control box underside and secure with the 2 bolts provided, slacken the knurled locking collar on the top stem and insert the middle stem.

Insert the lower stem in the middle stem and tighten locking collar. Twist the head cable around the stems until the slack is taken up, then connect the head to the lower stem using the bolt provided.

Height adjustment can be achieved by slackening off the knurled locking collars and extending or shortening the whole assembly.

## BATTERIES

Before you can operate your 770 you need to purchase 4 x PP3 batteries, preferably made by a well known manufacturer.

**N.B.** Over 80% of all faults occurring with metal detectors can be traced to poorly fitted or faulty batteries — even new ones!

By removing battery covers (F) access is gained to the battery compartments. To remove battery covers gently depress ribbed end and slide forward. Connect batteries firmly onto battery clips and replace battery covers.

Battery life will be longer if headphones are used.

Diagram 2.

*Please note that the second battery compartment is on the other side of the control box.*

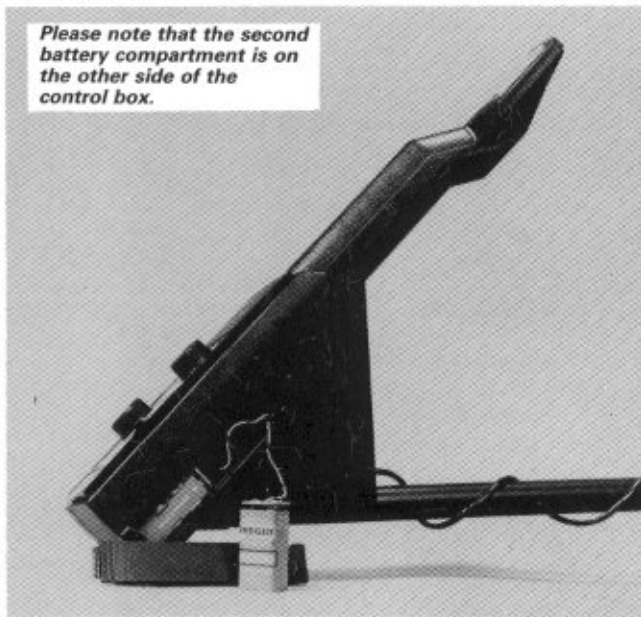

## BATTERY CHECK

As a guide to battery condition a battery check is provided (E). To check batteries, simply depress button (E) (**N.B.** machine must be switched on) and note the position of the meter needle, the further the needle is to the right of the "Change Battery" mark the better the condition of the batteries.

## TUNING YOUR DETECTOR

First switch on knob (A) and whilst depressing Auto Tune Button (C) turn clockwise until a faint noise is heard (and the meter needle centres). Then release Auto Tune Button. The best optimum tuning point is where the sound can just be heard if the machine is operated on a silent setting or where the noise is too loud sensitivity will be lost.

**N.B.** Before tuning machine ensure no metal objects are in the vicinity.

## RE-TUNING

Should the detector go out of tune for any reason, e.g., changes in temperature or ground conditions, encounters with large metal objects or an alteration of the discriminate control, simply depress the auto tune button and the detector will return to the pre-selected optimum tuning point.

## DISCRIMINATION

The 770 has a variable discrimination control which allows the operator to choose from any setting between all metal detection (Reject 0) to iron and silver paper rejection (Reject 10).

To adjust the Discriminate Level Control (B) depress the Auto Tune Button turn discriminate level control to the desired level and release Auto Tune Button.

Discrimination of a target object is indicated by a reduction in signal strength and by the meter moving to the left. For example, with the reject setting at 5 an iron nail will give a negative reaction (reduction in sound, meter moves to the left) whereas on a coin there will be a positive reaction (an increase in sound and a meter movement to the right).

All TR discriminators suffer from anomalies when objects are close to the search head. This is indicated by receiving a positive and negative reaction from the same object. If this occurs simply raise the detector about 3" re-tune and scan again.

## GROUND EFFECT

The signal of your detector will be affected by the type of terrain you are searching. Normally this effect produces an increase or decrease in the audio signal when the search head is raised from the ground. This effect can be controlled in two ways. If the search head is kept at a constant height the effect of the ground will be constant. The second method should only be used when the effect is severe. This method is to de-tune the machine so that it is less sensitive to the ground. However this will have the effect of making the machine less sensitive to coins as well.

## USE OF YOUR DETECTOR IN THE FIELD

### Detecting

To test for the type of signal you will get, take a coin or metal object and with the detector set up on a table tuned as previously described, move the metal object towards and across the search head. You will note that the volume will increase quickly as the metal object passes across the search head, with the loudest sound occurring when the search head is immediately centred over the metal object. As the object passes beyond the search head the sound will quickly fade.

TR Detectors employ a Total Response search head which means that the object can be detected across the full width, back to front, of the search head.

See Diagram 3.

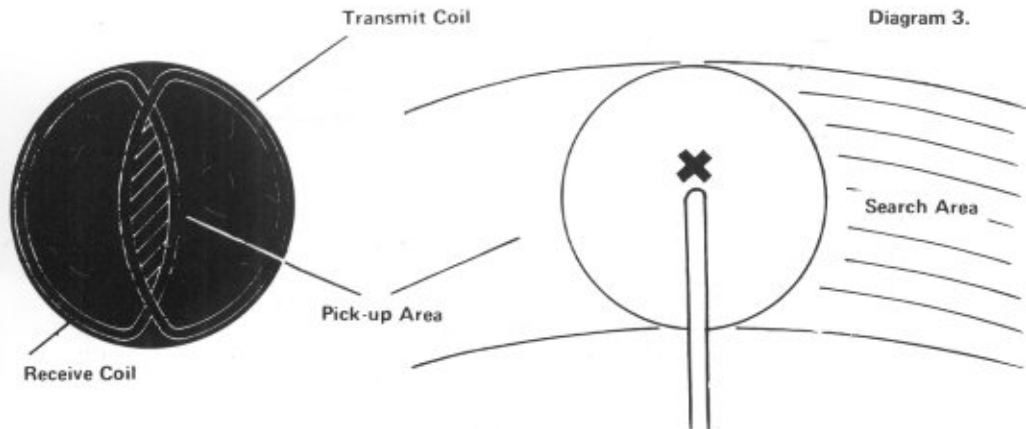

## Detection Range

Detection ranges will vary depending on the size of the object, the length of time an object has been buried, and the type of ground the object is buried in. The best ground conditions are dry well compacted soils then coins can be found at the greatest depths if they have been buried for some time and the coin has interacted with the salts in the ground, thereby appearing larger to the detector. The worst conditions for detecting are on loosely compacted or freshly dug ground or when the object has only recently been buried. In these conditions detection range will be reduced, 90% of all objects are found within 6" of the surface. Adverse soil conditions can reduce depth of detection by more than half.

## Determining the Target Size and Depth

An operator who is familiar with his instrument will be able to do an excellent job of determining object size, shape and depth before he digs. The technique is learned from careful analysis of the audio signals coming from the detector. Each time a signal is heard, listen for any peculiar characteristics it may have; determine over how large an area you get a detector signal; and try to "outline" the object before you dig. Listen for the sharpness or dullness of the signals and determine the magnitude of strength of the signal. A coin will have a sharp signal, a nail a fuzzy signal.

## RECOMMENDATIONS FOR USE

Treasure hunting can be a profitable and rewarding hobby, if approached in a patient and diligent manner. Time spent researching to locate a worthwhile site for a search can be time wasted if your search is hasty and erratic.

To achieve maximum results, it is important, then, to decide on your approach to each particular site, in advance of the actual search.

Tactics will be decided by the type of site — it is more profitable to scan a small area thoroughly than to conduct a haphazard search of the total site. However, when the site is too far away for you to make several return visits, a plan should be adopted which gives maximum site coverage, at the same time as indicating the most likely areas for detailed search.

One method is to divide the area into large squares of a 'criss-cross' search pattern, starting along the left hand perimeter, search in a straight line, marking the location of any finds with small sticks, until you have covered the length of the site. Then, moving approximately ten feet to the right, search in a straight line parallel to the first line of search. This pattern should be repeated until the right hand perimeter is reached; then follow a similar pattern ACROSS the tracks of the first lines of search. (see diagram 4).

It quite often happens that where one find is made, other finds will be made in the immediate vicinity. Accordingly, places having the highest density of markers, placed where finds were made, represent the most likely spots for further finds.

The detailed search is made by marking out strips of a width determined by the sweep of the detector, and moving forwards the approximate diameter of the search head after each sweep until the 'strip' has been completely covered. The adjacent strips are covered in a similar manner, until the complete area has been thoroughly searched. (see diagram 5).

Wooden pegs and string are ideal for marking out areas, but very often natural land marks such as trees, rocks and plants can, with practice, prove just as effective.

Whilst searching it is important to remember that the search head should be kept as close to the ground as possible. This ensures maximum depth penetration. There is a maximum detection range and a large gap between head and ground reduces the effective depth of the search.

See Diagram 6.

## CARE AND MAINTENANCE

### Care of Your Detector

The working life of your detector will be shortened by careless use or neglect of the unit. Think of your detector as a scientific instrument NOT A TOY. Your detector is designed to withstand rugged handling on any terrain, but mis-use or lack of due attention will tell in the end.

After using your detector in a hostile environment (salt water, sand, etc.), the exterior parts of the casing should be flushed with fresh water, paying particular attention to the head, and carefully wiped dry. Foreign particles in the control box can be removed by brushing carefully (or with compressed air or vacuum cleaner).

Diagram 4.

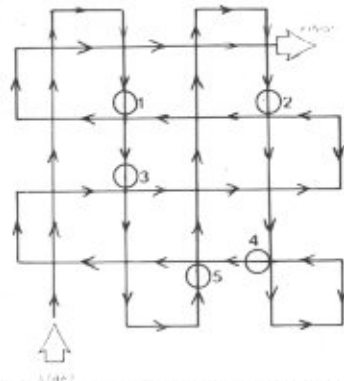

On arrival at the site a criss cross search is made marking the positions of finds: 1, 2, 3, 4, and 5. A detailed search of the area around the finds is made on completion of the criss cross search.

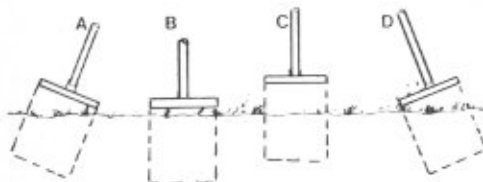
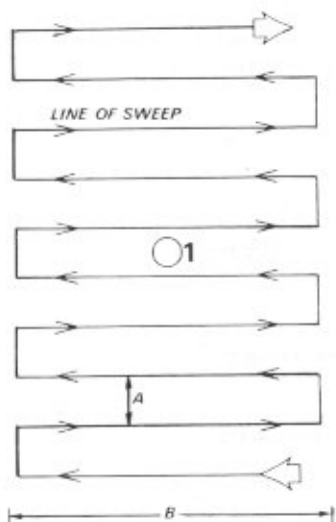

Diagram 6.

It is essential that the search head is kept close and parallel to the ground to avoid missing finds as in A, C, and D.

Diagram 5.



An area ten foot square is marked out around the find located by criss cross search. This is then divided into strips which are carefully searched.  
Distance A = width of the detector's pick-up area.  
Distance B = length of a comfortable sweep.

### Salt Damage

If you use your detector continually in a salty environment, particularly when the wind is blowing off the sea, salty air can penetrate the control box.

Corrosion can occur in vital parts of the delicate electronic circuitry.

It is, therefore, recommended that precautions such as covering the control box with polythene be taken to avoid damage.

The guarantee cannot cover such occurrences and any repairs needed because of salt water or spray will be charged.

### The Use of Solvents

It has been found that some types of solvent used for cleaning circuitry will in fact melt the plastic covered components.

Clean the circuit board only with recognised circuit board cleaning agents.

The life of the controls may be extended by periodic (100 hours of use) application of small quantities of light lubricant to the spindles, threads and knob grub screws (3 in 1 or similar household oil is suitable).

This operation requires the knobs to be removed.

Light packing grease should be smeared on the threads of the locking collar, and at the same time, the head fixing bolt. Do not store the detector in a damp place.

If the detector is to be stored, remove the batteries as they may leak and corrode the surrounding electronics.

### Detector Not Operating

- Check the conditions of batteries.
- Interchange batteries and ensure connections are correct and secure.  
Battery life can vary tremendously between makes, therefore your 'new' batteries may already be insufficiently powerful to run your detector.

### **Oscillating Signal Accompanied by Slight Meter Fluctuation**

- (a) Caused most often by outside equipment such as fluorescent lights, taxis, radios, power lines, and other metal detectors working nearby. Little can be done to alleviate the problem except to find a new site.

### **Intermittent Sound From Speaker**

- (a) This could be due to poor battery connections. Ensure they are tight and the batteries are securely clipped into place.
- (b) Radio transmission from passing taxi or vehicle using radio transmitter equipment.
- (c) Loose speaker, in which case the speaker needs fastening back into place.

### **The Detector Drifts Out of Tune**

- (a) Temperature drift caused by the change in air temperature when a machine is moved from a house or a car into the open.
- (b) The greater the change in temperature the more the drift, and up to 30 minutes may be needed for the electronic circuitry to acclimatize itself.
- (c) Sometimes battery drain can cause drift of signal. Replace batteries and this should help to maintain a stable signal.

Before returning a detector for repair to C-Scope ensure you have done the following:-

- (a) Read instructions thoroughly.
- (b) Tried new batteries and checked procedure outlined above.
- (c) Spoken to the local dealer about performance of the detector, especially if you are still unfamiliar with metal detectors in general.

## **A GUIDE TO TREASURE HUNTING**

### **THE IMPORTANCE OF THE RIGHT APPROACH**

#### **HOW TO LOOK**

#### **THE BEST SITES**

#### **WHERE TO LOOK**

#### **TREASURE HUNTING & THE LAW**

#### **THE RIGHTS OF THE FINDER**

#### **TREASURE TROVE**

#### **A CODE OF CONDUCT**

### **THE IMPORTANCE OF THE RIGHT APPROACH**

Your detector alone is not a guarantee of successful treasure hunting. Any detector needs an operator, and for the best results the operator needs the right approach, attitude and technique. Too many beginners neglect the importance of pre-planning and research before using their detector in the field, and patience and technique during the actual search.

A successful search should begin with research sometime before the day of the actual search. The extent and thoroughness of your research will be one of the major factors in the success of your detecting. You should aim to get as complete an understanding as possible of the local history and geography.

The key to the choice of the site is to think of people, where they congregated over the past few hundred years. What were their customs and pursuits? Where did they spend money? Where did they carry money? The answers are not Roman sites, nor are they associated with mystic treasure stories of crocks of gold. Rather, they are unassuming, undramatic places, like public footpaths and ancient rights of way, old houses and so on.

When you have chosen your site, allocate a whole day from early morning to early evening for the search. Make sure that you have all equipment you are likely to need. Your detector should be checked before starting out, and you should always carry a spare set of batteries. You will also need a strong, sharp trowel. It is also a good idea to have a set of lines and pins so that you can lay out your search area scientifically. Most beginners make the mistake of rushing about hoping to chance upon a rare find. If for example, there happened to be a valuable ring that was buried 4" deep on the site you were searching, if you rushed about haphazardly and quickly on the site, the odds would be very much against your finding it. On the other hand, if you pegged out the area scientifically and searched slowly and thoroughly, the odds of finding the ring would be much more in your favour.

Remember, BE PATIENT and WORK SLOWLY. Do not try to cover too large an area. Restrict yourself to a small area and work through it thoroughly. Make a note of the position and extent of the area, and then when you return you can start again further on without missing any ground or covering the same area twice.

It is also important to keep the detector head as close to the ground as possible. Ideally, you should "iron" the ground with the search head of the detector, so that you do not lose any detection range. Similarly, if you work slowly and carefully you should be able to distinguish the faint signals as well as the clear-cut signals and further increase your finds.

The technique of getting the best out of your detector is not learnt overnight. You need to get as much experience as possible so that you can recognise every kind of signal. Indeed, a good detector operator can often tell you what is being detected before it is unearthed.

## WHERE TO LOOK

It has already been mentioned that the most profitable sites are those where people have congregated, walked, or lived over the past few hundred years, or even longer.

**Houses** If you live in a Victorian house you might not even have to leave your home for your treasure hunting. Old houses have seen remarkable amounts of money pass over the threshold during their history. Britain has had its fair share of misers, and it is surprising how many little hoards or boxes containing savings turn up.

One area to concentrate on is under skirting boards, where coins or rings might have rolled. Doorways too, may prove rewarding as many money transactions take place there. Old fireplace and chimneys should be well scanned with the detector, as these are favourites for finding hoards, etc. The floor-boards should be examined carefully and special attention paid to short lengths which could conceal caches. It is also surprising how much money is lost in old chairs, so give them a look over. And then, of course, the garden should be thoroughly examined. The amount of coins lost in old houses cannot be over-estimated. Most coin shops confirm that many people bring coins in for valuation that they have found *accidentally* in their houses. A deliberate search in a house of the right age can hardly fail to be rewarding.

**Rivers** The best parts of rivers to concentrate on are (1) public footpaths along river banks. (2) Bends of the river where erosion has been taking place. (3) Bends in the river where coins are likely to be deposited against a particular bank by the action of the current. (4) Areas downstream of old drainage pipes or upstream of projections such as wooded piers, or other obstructions. (5) Old fords or bridges. (6) Areas exposed at low tide where eddy action has been taking place.

Tidal rivers are particularly interesting, as once you have found a good site or spot where coins have collected due to the currents, you can search the area well one day and still return at a later date for more rewarding finds. Rivers tend to sort out their load and distribute it according to weight along the bank in places like those itemised above.

**Beaches** Beaches are, without a doubt, the favourite haunt of the average British treasurer hunter. At one time or another, almost everybody has made the journey to the coast. The beaches are the only place where people undress publicly; anyone who has attempted to change into a bathing costume discreetly and then store their coins on the open sand knows the chances of losing not only coins, but jewellery and wristwatches, too.

Once an object has been mislaid on the beach, it is maddeningly difficult to find it again.

There is also a high incidence of wrecks along our coasts, the contents of which are deposited at intervals on our beaches.

These factors contribute to make our beaches probably the richest site for the amateur treasure hunter. The best times to explore beaches are after heavy storms when the sand has been thoroughly stirred up and shifted. A good place to concentrate on is along or just below the tide marks, which are easily identified by the lines of debris that are left. Under piers or alongside breakwaters also usually pay dividends.

Other good sites are:- Fairgrounds, Children's Playgrounds, Tobbogan runs and Demolition Sites.

## TREASURE HUNTING AND THE LAW

### RIGHTS OF THE FINDER

The rights of the finder fall into two distinct classes. The first relates to objects that have recently been lost, and the second to items of gold or silver which are subject, or might by subject, to the laws of the Treasure Trove.

In the first place, where the object has been recently lost and found and is valuable, it should be handed to the Police as soon after it has been found as possible. The Police will then attempt to locate the owner. If they succeed in locating the owner, he has the legal right to the object and is not legally bound to reward the finder. That is a matter for the owner's conscience.



In the event of the Police failing to locate the owner they will probably return the object to the finder. If, however, the owner makes a claim for the object at a later date, the finder must return the item to the owner.

If the owner is not located the finder has the best rights to ownership, provided that the object was not found on private property, in which case the owner of the land often has a better right than the finder. The solution here, of course, is to obtain permission beforehand and to come to some agreement with the landowner with regard to the division of any finds.

If on the other hand, the find of gold or silver can be proved to have been deliberately concealed, with a view to recovery at a later date, the find comes under the laws of the Treasure Trove. If the objects cannot be proved to have been deliberately concealed, the find cannot be declared Treasure Trove. Usually this point centres around the quantity of coins in a hoard, or whether the find is in a container. Obviously, if there are a hundred or so coins in a pot, they were almost certainly deliberately concealed. If, however, there are only one or two coins, it is more likely that they were lost accidentally.

If the objects are declared Treasure Trove, the finder has no need to worry, for he is rewarded with a cash settlement to the full market value of the find.

When the objects are not declared Treasure Trove, the owner of the land on which the find was made usually has a better claim to ownership than the finder.

In Scotland all newly discovered ancient objects of all metals, whether deliberately concealed or not are subject to the same procedure as Treasure Trove finds in England.

## CODE OF CONDUCT

1. Do not interfere with archaeological sites or ancient monuments. Join your local archaeological society if you are interested in ancient history.
2. Do not leave a mess. It is perfectly simple to extract a coin or other small object buried a few inches under the ground without digging a great hole. Use a sharpened trowel or knife to cut a neat circle or triangle (do not remove the plug of earth entirely from the ground); extract the object; replace the soil and grass carefully and even you will have difficulty in finding the spot again.
3. Help keep Britain tidy – and help yourself. Bottle tops, silver paper and tin cans are the last things you should throw away. You could well be digging them up again next year. Do yourself and the community a favour by taking all the rusty junk you find to the nearest litter bin.
4. Do not trespass. Ask permission before venturing on to any private land.
5. Report all unusual historical finds to the local museum and get expert help if you accidentally discover a site of archaeological interest.
6. If you discover any live ammunition or any lethal object such as an unexploded mine, do not touch it. Mark the site carefully and report the find at once to the local Police.
7. Learn the treasure trove laws and report all finds of gold or silver objects to the Police. If a coroner's inquest finds that the objects were deliberately concealed with the intention of retrieving them, they become the property of the Crown and therefore treasure trove. But even if the British Museum decides to exercise its right to keep the property, the finder is granted the full market value.
8. Respect the Country Code. Do not leave gates open when crossing fields, and do not damage crops or frighten animals.
9. Never miss an opportunity to show and explain your detector to anyone who asks about it. Be friendly. You could pick up some useful clues to another site. If you meet another detector user, introduce yourself. You may learn much about the hobby from each other.
10. Remember that when you are out with your detector, you are an ambassador for the amateur treasure hunting fraternity. Do not give us a bad name.

**Notes:**

# C.SCOPE

Kingsnorth Technology Park, Wotton Road, Ashford, Kent TN23 6LN  
Telephone: (01233) 629181 Fax: (01233) 645897